

48.8±0.5

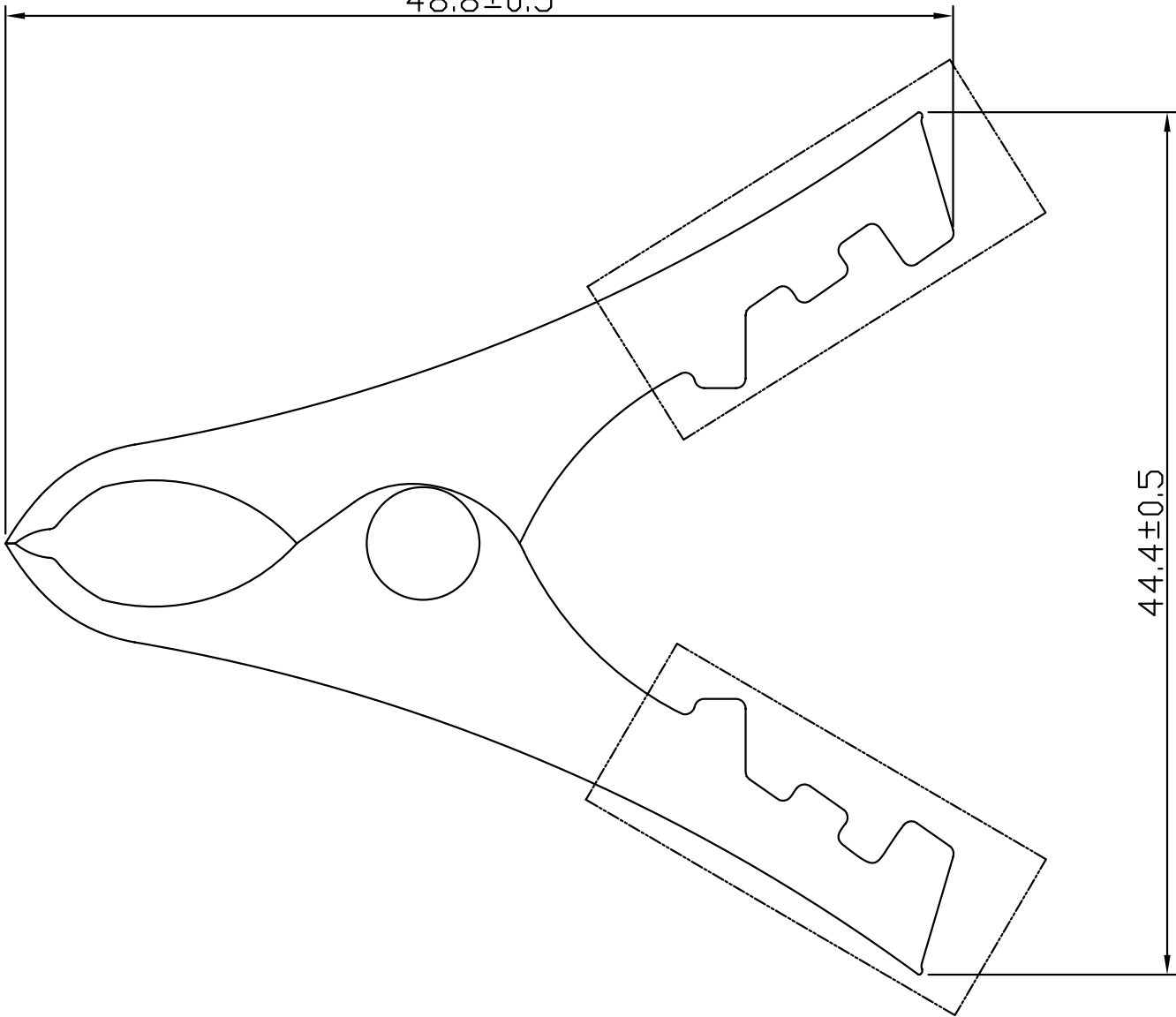

44.4±0.5